

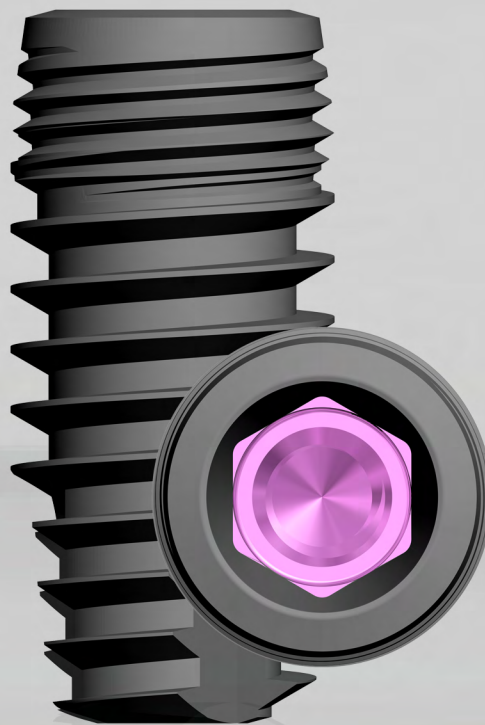

BlueSkyBio

Your Partner In Digital Dentistry

BIO | Max



2020

Product Catalog

BIO | Max

Nobel Active® Compatible

January 2020

Table of contents

Implants	2
Short Implants	2,3
3.0mm Implants	3
Healing Abutments	3
MPA Custom Abutments	4
KISS Abutments	4
UCLA Gold and Plastic Castable Abutments	4,5
Angled Abutments	5
Multi Unit Abutments	5,6
Standard Temporary Abutment	6
Digital Temporary Abutment	6
Digital Abutment	6
Intraoral Scanning Parts	7
Overdentures - Straight and Angled	7,8
Analogs	8
Impression Transfers	8
Surgical Instruments	8,9

Table of contents

Surgical Instruments	9,10
Safety Stop Surgical Kit	10,11
Fully Guided Keyless Kit	11,12
Hammerless Crestal Sinus Lift Kit	13
BIO BlueTouch	13
Suture	13
Master Bone Expander Kit	14
Guided Sinus Lift Kit	14
Safety Lateral Sinus Kit	14
Guide Tubes	14-18
Terms and Conditions	19

Implants

Packs include BIO | Max implant and 1 mm cover screw.

BIO | Max implants are prosthetically compatible with NobelActive® NP platform prosthetic abutments**.

BIO | Max Prosthetics are compatible with NobelActive® NP implant platform.

3.5mm Ø NP platform switched

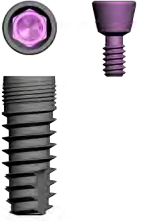

Size	Part #
8mm	IJH3508
10mm	IJH3510
11.5mm	IJH3511
13mm	IJH3513
16mm	IJH3516

4.3mm Ø NP platform switched



Size	Part #
8mm	IJH4308
10mm	IJH4310
11.5mm	IJH4311
13mm	IJH4313
16mm	IJH4316

5.0mm Ø NP platform switched



Size	Part #
8mm	IJH5008
10mm	IJH5010
11.5mm	IJH5011
13mm	IJH5013
16mm	IJH5016

6.0mm Ø NP platform switched



Size	Part #
8mm	IJH6008
10mm	IJH6010
11.5mm	IJH6011

7.0mm Ø NP platform switched



Size	Part #
8mm	IJH7008
10mm	IJH7010
11.5mm	IJH7011

Short Implants

Kits include BIO | Max implant and 1 mm cover screw.

BIO | Max implants are prosthetically compatible with NobelActive® NP platform prosthetic abutments**.

BIO | Max Prosthetics are compatible with NobelActive® NP implant platform.

4.3mm Ø NP platform switched



Size	Part #
6mm	IJH4306

5.0mm Ø NP platform switched



Size	Part #
6mm	IJH5006

All prices are available in the product section of our website. Volume discounts are available for some items.

Blue Sky Bio is not affiliated with Nobel Biocare.

Blue Sky Bio's products are not manufactured, endorsed, or warranted by Nobel.

** BIO | Max implants are not compatible with Nobel Biocare Gold Adapt non-engaging UCLA abutments.

6.0mm Ø NP platform switched



Size	Part #
6mm	IJH4306



7.0mm Ø NP platform switched



Size	Part #
6mm	IJH5006



3.0mm Implants

Kits include BIO | Max implant and 1mm cover screw.

Requires DRILLN26S or DRILLN26L.

BIO | Max implants are prosthetically compatible with NobelActive® NP platform prosthetic abutments**.

BIO | Max Prosthetics are compatible with NobelActive® NP implant platform.

3.5mm Ø NP platform switched



Size	Part #
10mm	IJH3510
11.5mm	IJH3511
13mm	IJH3513

Healing Abutments

BIO | Max implants are prosthetically compatible with NobelActive® NP platform prosthetic abutments**.

BIO | Max Prosthetics are compatible with NobelActive® NP implant platform.

3.5 Healing Abutments

	Size	Part #
	3mm height	HJH3503
	5mm height	HJH3505

4.3 Healing Abutments

	Size	Part #
	3mm height	HJH4303
	5mm height	HJH4305

4.7 Healing Abutments

	Size	Part #
	3mm height	HJH4703
	5mm height	HJH4705

6.0 Healing Abutments

	Size	Part #
	3mm height	HJH6003
	5mm height	HJH6005

Cover Screw

Size	Part #
Cover Screw	CJH

All prices are available in the product section of our website. Volume discounts are available for some items.

Blue Sky Bio is not affiliated with Nobel Biocare.

Blue Sky Bio's products are not manufactured, endorsed, or warranted by Nobel.

** BIO | Max implants are not compatible with Nobel Biocare Gold Adapt non-engaging UCLA abutments.

MPA Custom Abutments

MPA Multi Purpose Abutments: Abutments can be used as an implant level impression transfer and the final abutment. Kits include MPA Abutment, Analog and Fixation Screw.

BIO | Max implants are prosthetically compatible with NobelActive® NP platform prosthetic abutments**.

BIO | Max Prosthetics are compatible with NobelActive® NP implant platform.

4.1 Abutment NP platform

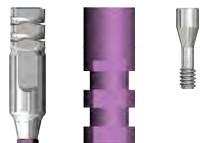

Size	Part #
MPA Kit	KMPAJH41
MPA Abutment	MPAJH41
Implant level Analog	BIJH

4.7 Abutment NP platform

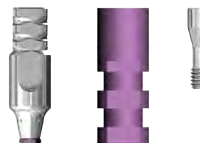

Size	Part #
MPA Kit	KMPAJH47
MPA Abutment	MPAJH47
Implant level Analog	BIJH

6.0 Abutment NP platform

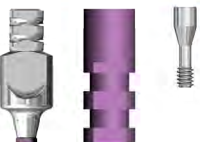

Size	Part #
MPA Kit	KMPAJH60
MPA Abutment	MPAJH60
Implant level Analog	BIJH

KISS Abutments

Fixation screw included

KISS Complete Kits include KISS abutment, screw, metal analog. two resin analogs, impression transfer, engaging and non-engaging waxing sleeves and temporary sleeve.

KISS Impression Kits include two resin analogs, impression transfer, engaging and non-engaging waxing sleeves and temporary sleeve.

BIO | Max implants are prosthetically compatible with NobelActive® NP platform prosthetic abutments**.

BIO | Max Prosthetics are compatible with NobelActive® NP implant platform.

NP Platform Regular KISS



Size	Part #
KISS Abutment 1.5mm collar	ASJHR015

NP Platform Wide KISS



Size	Part #
KISS Abutment 1.5mm collar, Wide	ASJHW015

UCLA Gold Castable Abutments

Fixation screw included

Please see the KISS abutment section for whiteMetal abutment screw retained restorations.

BIO | Max implants are prosthetically compatible with NobelActive® NP platform prosthetic abutments**.

BIO | Max Prosthetics are compatible with NobelActive® NP implant platform.

Abutment NP platform



Size	Part #
Gold UCLA Abutment	AUCLAJHG
Additional Abutment Screw, UCLA, BIO Max	SRJH

Abutment NP platform



Size	Part #
Gold Non-Engaging UCLA Abutment	AUCLAJHNG
Additional Abutment Screw, UCLA, BIO Max	SRJH

All prices are available in the product section of our website. Volume discounts are available for some items.

Blue Sky Bio is not affiliated with Nobel Biocare.

Blue Sky Bio's products are not manufactured, endorsed, or warranted by Nobel.

** BIO | Max implants are not compatible with Nobel Biocare Gold Adapt non-engaging UCLA abutments.

Plastic Castable Abutments

Abutment NP platform

Size	Part #
Plastic UCLA Abutment (including screw)	PAUCLJHNP
Additional Abutment Screw, UCLA, BIO Max SRJH	

Abutment NP platform

Size	Part #
Plastic Non-Engaging UCLA Abutment (including screw)	PAUCLJHNP
Additional Abutment Screw, UCLA, BIO Max SRJH	

Abutment NP platform

Size	Part #
MPA Plastic Kit Castable Non - Engaging (including abutment, analog and screw)	KPMPAJHNE41
MPA Plastic Abutment Castable Non - Engaging 4.1mm	PMPAJHNE41

Angled Abutments

Fixation screw included.

BIO | Max implants are prosthetically compatible with NobelActive® NP platform prosthetic abutments**.

BIO | Max Prosthetics are compatible with NobelActive® NP implant platform.

Angled Abutments

Size	Part #
Angled Abutment 15 degree	AAJH15

Angled Abutments

Size	Part #
Angled Abutment 30 degree	AAJH30

Multi Unit Abutments

Multi Unit Abutments

Size	Part #
Abutment Multi Unit Straight, Max, 3.5mm x 1.5mm cuff - Requires .080 Hex Driver	AMUSJH15
Abutment Multi Unit Straight, Max, 3.5mm x 3.0mm cuff - Requires .080 Hex Driver	AMUSJH30

Size	Part #
Angled Abutment Multi Unit, Max, 3.5mm 17 degree	AAMUJH17
Angled Abutment Multi Unit, Max, 3.5mm 30 degree	AAMUJH30

Components

Size	Part #	Size	Part #
Comfort Cap for all Multi Unit Abutments	CMU	MMUTC Casting Sleeve	PWAXMUTC
Combination Impression Transfer, Temporary Abutment and Castable Sleeve, Plastic - Requires screw SMUS or SMUL	MMUP	Analog, Multi Unit	BMU
Combination Impression Transfer/ Temporary Abutment - Titanium Alloy - Requires screw SMUS or SMUL	MMUT	Angled Multi Unit Abutment Delivery Aid	DSMU
Multiunit Coping, Temporary Abutment Titanium Alloy - Requires screw SMUS or SMUL	MMUTC	Screw Multi Unit Impression Transfer, long	SMUL
		Screw, Multi Unit, Castable Abutments, short	SMUS



All prices are available in the product section of our website. Volume discounts are available for some items.

Blue Sky Bio is not affiliated with Nobel Biocare.

Blue Sky Bio's products are not manufactured, endorsed, or warranted by Nobel.

** BIO | Max implants are not compatible with Nobel Biocare Gold Adapt non-engaging UCLA abutments.

Components







	Size	Part #		Size	Part #
	Multi Unit Titanium Coping Thimble	MUT		.080 Hex Driver for straight Multi Unit Abutments	HFD
	MMUTC Spacer Sleeve	PSPACEMUTC			

Standard Temporary Abutments

	Size	Part #		Size	Part #
	Engaging Pickup Abutment for Permanent and Temporary Screwentable Restorations (includes screw)	ACALJHNP		Non-Engaging Pickup Abutment for Permanent and Temporary Screwentable Restorations, (includes screw)	ACALJHNPNC







Digital Temporary Abutments

Digital Temporary Abutments



	Size	Part #		Size	Part #
	Digital Abutment for temporary abutment, Narrow Platform (includes fixation screw)	ABJHNP		Titanium Digital Abutment - without hex, Narrow Platform (includes abutment screw)	ABJHNPNC
	Digital Abutment for temporary abutment 1.8mm collar, Narrow Platform (includes fixation screw)	ABJHNP18		Digital Abutment for temporary abutment - non engaging, Narrow Platform Platform (includes abutment screw)	ABJHNPNC
	Digital Abutment for temporary abutment, Mini, Narrow Platform (includes fixation screw)	ABJHNP18		Angled Screw Driver (20Ncm max torque)	SDUGA

Digital Abutments

Digital Abutments

	Size	Part #		Size	Part #
	Digital Abutment for temporary abutment, Narrow Platform (includes fixation screw)	ABJHNP		Titanium Digital Abutment - without hex, Narrow Platform (includes abutment screw)	ABJHNPNC
	Digital Abutment for temporary abutment 1.8mm collar, Narrow Platform (includes fixation screw)	ABJHNP18		Digital Abutment for temporary abutment - non engaging, Narrow Platform Platform (includes abutment screw)	ABJHNPNC
	Digital Abutment for temporary abutment, Mini, Narrow Platform (includes fixation screw)	ABJHNP18		Angled Screw Driver (20Ncm max torque)	SDUGA

Angled Digital Abutments

	Size	Part #		Size	Part #
	Titanium Angled Base Abutment for temporary abutment, Narrow Platform (includes abutment screw)	AABJHNP		Titanium Angled Base Abutment for temporary abutment - without hex, Narrow Platform (includes abutment screw)	AABJHNPNC
	Titanium Angled Base Abutment for temporary abutment - non engaging, Narrow Platform (includes abutment screw)	AABJHNPNC			

All prices are available in the product section of our website. Volume discounts are available for some items.



Blue Sky Bio is not affiliated with Nobel Biocare.

Blue Sky Bio's products are not manufactured, endorsed, or warranted by Nobel.



** BIO | Max implants are not compatible with Nobel Biocare Gold Adapt non-engaging UCLA abutments.

Intraoral Scanning Parts

Master Overdenture Restorative Kits Regular - Chairside

	Size	Part #
	Rosetta Scanpost Extender for Regular Digital Abutments	OPTIBASER
	Regular Ball ScanSnap (required for Exocad or 3Shape)	BALL6
	Rosetta Scanpost Extender for Mini Digital Abutments	OPTIBASEN

Master Overdenture Restorative Kits Regular - Laboratory

	Size	Part #
	Mini Ball ScanSnap (required for Exocad / 3Shape)	BALL6MI
	ScanFlag Scanpost for Regular Digital Abutments	OPTICSTB
	ScanFlag Scanpost for Mini Digital Abutments	OPTICSTBMI

Overdentures

Master Overdenture Restorative Kits Regular - Chairside

	Size	Part #
	Master Overdenture Restorative Kit - Chairside, regular x 3.0mm height	MORKJH10
	Master Overdenture Restorative Kit - Chairside, regular x 3.0mm height	MORKJH30
	Master Overdenture Restorative Kit - Chairside, regular x 5.0mm height	MORKJH50

Master Overdenture Restorative Kits Regular - Laboratory

	Size	Part #
	Master Overdenture Restorative Kit - Laboratory, regular x 3.0mm height	MORKJH10-L
	Master Overdenture Restorative Kit - Laboratory, regular x 3.0mm height	MORKJH30-L
	Master Overdenture Restorative Kit - Laboratory, regular x 5.0mm height	MORKJH30-L

Angled Overdentures



Angled Overdenture Restorative Kits Regular - Chairside

	Size	Part #
	Angled Overdenture Restorative Kit, 17 degrees - Chairside	ARKJH17

Angled Overdenture Restorative Kits Regular - Laboratory

	Size	Part #
	Angled Overdenture Restorative Kit, 17 degrees - Laboratory	ARKJH17-L

Angled Super Snap Overdenture Restorative Kits - Chairside Requires No Metal Housing

	Size	Part #
	Angled Super Overdenture Restorative Kit, 17 degrees - Chairside	ASRKJH17
	Angled Super Overdenture Restorative Kit, 17 degrees - Chairside	ASRKJH30

Angled Super Snap Overdenture Restorative Kits - Laboratory Requires No Metal Housing

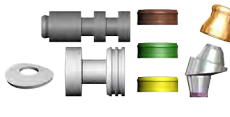
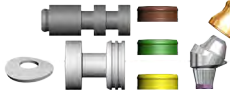
	Size	Part #
	Angled Super Overdenture Restorative Kit, 17 degrees - Laboratory	ASRKJH17-L
	Angled Super Overdenture Restorative Kit, 17 degrees - Laboratory	ASRKJH30-L















All prices are available in the product section of our website. Volume discounts are available for some items.

Blue Sky Bio is not affiliated with Nobel Biocare.

Blue Sky Bio's products are not manufactured, endorsed, or warranted by Nobel.

** BIO | Max implants are not compatible with Nobel Biocare Gold Adapt non-engaging UCLA abutments.

Overdenture Products

	Size	Part #		Size	Part #
	Complete Flat Snap Restorative Kit	NOPK		Super Insert – Light retention, requires no housing (includes 2 inserts and 2 block out rings) Extreme long lasting retention on parallel implants.	FOPR
	Analog	FSA		Resin Impression transfer (2 Pack)	FSI
	Replacement Inserts Strong Retention (4 Pack)	FSCS		Titanium Housing	HGFS
	Replacement Inserts Medium / Light Retention (4 Pack)	FSCG		Block Out Ring (10 Pack)	RSD01
	Resin Impression transfer (2 Pack) and FSCB (4 Pack)	FSCR		Insert Placement/Removal Instrument	TFSU
	Processing Inserts No Retention (4 Pack)	FSCB		Insert Placement/Removal Instrument	TFSU
	Super Insert – Strong retention, requires no housing (includes 2 inserts and 2 block out rings) Extreme long lasting retention on parallel implants.	FOPS			
	Super Insert – Medium retention, requires no housing (includes 2 inserts and 2 block out rings) Extreme long lasting retention on parallel implants.	FOPG			

Analogs



	Size	Part #
	Implant Level Analog	BIJH

Impression Transfers

	Size	Part #
	Closed Tray Impression Transfer	MIJH

	Size	Part #
	Open Tray Impression Transfer	MIJH - OT

Surgical Instruments

Surgical Instruments		
	Size	Part #
	Adapter for NB Ratchet	NA
	Torque/Ratchet	TR-900-01
	Screwdriver short	SDS048

All prices are available in the product section of our website. Volume discounts are available for some items.

Blue Sky Bio is not affiliated with Nobel Biocare.



Blue Sky Bio's products are not manufactured, endorsed, or warranted by Nobel.

** BIO | Max implants are not compatible with Nobel Biocare Gold Adapt non-engaging UCLA abutments.

Surgical Instruments

	Size	Part #
	Screwdriver long	HNTL
	Handpiece Implant Driver Short	DMJHS
	Handpiece Implant Driver Long	DMJHL
	Ratchet Implant Driver Short	DTJHS
	Ratchet Implant Driver Long	DTJHL
	Starter Drill Short	DRILLNSS
	Starter Drill Long	DRILLNSL
	Drill 2.2mm Short	DRILLN22S
	Drill 2.2mm Long	DRILLN22L
	Implant Drill Short 3.5mm	DRILLN35S
	Implant Drill Long 3.5mm	DRILLN35L
	Implant Drill Short 4.3mm	DRILLN43S
	Implant Drill Long 4.3mm	DRILLN43L
	Implant Drill Short 5.0mm	DRILLN50S
	Implant Drill Long 5.0mm	DRILLN50L
	Implant Drill Short 7.0mm	DRILL6653S
	Instrument Box	MIB
	BIO Max Complete Surgical Kit	MCSK

Other Surgical Instrumentation

	Size	Part #
	Lindemann Bur	LINDR-S21
	Lance Drill	LD150
	Trepine Bur	TPHB-B6

All prices are available in the product section of our website. Volume discounts are available for some items.

Blue Sky Bio is not affiliated with Nobel Biocare.

Blue Sky Bio's products are not manufactured, endorsed, or warranted by Nobel.

** BIO | Max implants are not compatible with Nobel Biocare Gold Adapt non-engaging UCLA abutments.

Other Surgical Instrumentation













	Size	Part #
	Final Drill for 7.0mm Implant, short	DRILL6653S
	Final Drill for 7.0mm Implant, short	DRILL6653S
	Angled Screw Driver (20Ncm max torque)	SDUGA
	Screw Removal Tool	AFSR

Safety Stop Surgical Kit



	Part #
Safety Stop Surgical Kit	SSSMNP

Safety Stop Kit Individual Components And Accessories

	Size	Part #
	Drill Stop 2.0 x 6mm	DRILNSTP2006
	Drill Stop 2.0 x 8mm	DRILNSTP2008
	Drill Stop 2.0 x 10mm	DRILNSTP2010
	Drill Stop 2.0 x 11.5mm	DRILNSTP2011
	Drill Stop 2.0 x 13mm	DRILNSTP2013
	Drill Stop 2.5 x 6mm	DRILNSTP2506
	Drill Stop 2.5 x 8mm	DRILNSTP2508
	Drill Stop 2.5 x 10mm	DRILNSTP2510
	Drill Stop 2.5 x 11.5mm	DRILNSTP2511
	Drill Stop 2.5 x 13mm	DRILNSTP2513
	Drill Stop 3.0 x 6mm	DRILNSTP3006
	Drill Stop 3.0 x 8mm	DRILNSTP3008
	Drill Stop 3.0 x 10mm	DRILNSTP3010
	Drill Stop 3.0 x 11.5mm	DRILNSTP3011
	Drill Stop 3.0 x 13mm	DRILNSTP3013
	Drill Stop 3.9 x 6mm	DRILNSTP3906









All prices are available in the product section of our website. Volume discounts are available for some items.

Blue Sky Bio is not affiliated with Nobel Biocare.



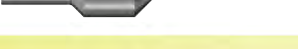

Blue Sky Bio's products are not manufactured, endorsed, or warranted by Nobel.

** BIO | Max implants are not compatible with Nobel Biocare Gold Adapt non-engaging UCLA abutments.





Safety Stop Kit Individual Components And Accessories

	Size	Part #
	Drill Stop 3.9 x 8mm	DRILNSTP3908
	Drill Stop 3.9 x 10mm	DRILNSTP3910
	Drill Stop 3.9 x 11.5mm	DRILNSTP3911
	Drill Stop 3.9 x 13mm	DRILNSTP3913
	Drill Stop 4.6 x 6mm	DRILNSTP4606
	Drill Stop 4.6 x 8mm	DRILNSTP4608
	Drill Stop 4.6 x 10mm	DRILNSTP4610
	Drill Stop 4.6 x 11.5mm	DRILNSTP4611
	Drill Stop 4.6 x 13mm	DRILNSTP4613
	Drill Stop Drill Extender	TDE

Fully Guided Keyless Kit

	Part #
	Fully Guided Keyless Kit GSKMNP
	Master Cylinder for Fully Guided Kit (Cerec M Master Tube Compatible) Tube524-504-4L
	Master Cylinder for Fully Guided Kit (Cerec M Master Tube Compatible) TUBE524-504-4LNF
	Master Cylinder for Fully Guided Kit (Cerec L Master Tube Compatible) TUBE524-504-4LNF

Guided Kit Individual Components And Accessories

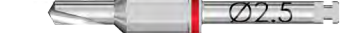
	Size	Part #
	Guide Drill 2.0 x 6mm	DRILG2006
	Guide Drill 2.0 x 8mm	DRILG2008
	Guide Drill 2.0 x 10mm	DRILG2010
	Guide Drill 2.0 x 11.5mm	DRILG2011
	Guide Drill 2.0 x 13mm	DRILG2013
	Guide Drill 2.5 x 6mm	DRILG2506

All prices are available in the product section of our website. Volume discounts are available for some items.

Blue Sky Bio is not affiliated with Nobel Biocare.

Blue Sky Bio's products are not manufactured, endorsed, or warranted by Nobel.

** BIO | Max implants are not compatible with Nobel Biocare Gold Adapt non-engaging UCLA abutments.

Guided Kit Individual Components And Accessories

	Size	Part #
	Guide Drill 2.5 x 8mm	DRILG2508
	Guide Drill 2.5 x 10mm	DRILG2510
	Guide Drill 2.5 x 11.5mm	DRILG2011
	Guide Drill 2.5 x 13mm	DRILG2513
	Guide Drill 3.0 x 6mm	DRILG3006
	Guide Drill 3.0 x 8mm	DRILG3008
	Guide Drill 3.0 x 10mm	DRILG3010
	Guide Drill 3.0 x 11.5mm	DRILG3011
	Guide Drill 3.0 x 13mm	DRILG3013
	Guide Drill 3.9 x 6mm	DRILG3906
	Guide Drill 3.9 x 8mm	DRILG3908
	Guide Drill 3.9 x 10mm	DRILG3910
	Guide Drill 3.9 x 11.5mm	DRILG3911
	Guide Drill 3.9 x 13mm	DRILG3913
	Guide Drill 4.6 x 6mm	DRILG4606
	Guide Drill 4.6 x 8mm	DRILG4608
	Guide Drill 4.6 x 10mm	DRILG4610
	Guide Drill 4.6 x 11.5mm	DRILG4611
	Guide Drill 4.6 x 13mm	DRILG4613
	Bone Crest Flattening Drill	DRILGFLAT
	Guided Implant Driver 8.5mm Offset	DTGJHNP85
	Guided Implant Driver Variable Offset	DTGJHNPVR
	Guide Fixation Pin (5 Pack)	PIN



All prices are available in the product section of our website. Volume discounts are available for some items.

Blue Sky Bio is not affiliated with Nobel Biocare.

Blue Sky Bio's products are not manufactured, endorsed, or warranted by Nobel.

** BIO | Max implants are not compatible with Nobel Biocare Gold Adapt non-engaging UCLA abutments.

Hammerless Crestal Sinus Lift Kit

Sinus Lift Kit		
	Size	Part #
	Hammerless Atraumatic Crestal Sinus Lift Kit	Sinus Kit
	Addition Guide Pin	GPINMAXNP

BIO | BlueTouch



	Size	Part #
	Touch-Screen Implant Motor (Adjustable Speed 300 – 40,000 RPM; up to 50 Ncm of torque for placement). Does not include handpiece.	BIO-BT



	Size	Part #
	Saeshin Strong 20:1 Handpiece External Irrigation (button)	ACL(B)-411
	Saeshin Traus 20:1 Non-Optic Handpiece External Irrigation (button)	CRB26XX
	Anthogyr Impulsion 20:1 Contra Angle (brush type); 50 Ncm tolerance	AHP-85P-I
	Anthogyr Mont Blanc 20:1 Contra Angle (high efficiency); 80 Ncm tolerance	AHP-85MB-X
	Anthogyr Mont Blanc 20:1 Contra Angle with Depth Control (high efficiency); 80 Ncm tolerance	AHP-85MB-CX

	Size	Part #
	Saeshin Strong 1:1 Straight Handpiece External Irrigation	AT-11
	Nozzle Clip 1:1 Straight Handpiece	ST-Nozzle
	Autoclavable Tubing Set for BIO BlueTouch	AE-24
	Autoclavable Pump Section for AE-24 Tubing Set	AE-24-PUMP
	Synthetic Premium Handpiece Lubricant	LU1011HS
	Lubricant Tool Attachment (necessary for lubricant)	LT1013HS

Sutures

All sutures are 60cm in length with reverse cutting needles and packaged 12 per box. Sutures sales are currently limited to U.S. customers.

	Size	Part #
	PGA Fast Resorb 4-0, FS-2 needle, 12/box	PGF40FS2
	PGA 4-0 violet, FS-2 needle, 12/box	PG40FS2
	Polypropylene (unbraided black) 5-0, P3 needle, 12/box	P50P3

	Size	Part #
	Nylon (unbraided black) 5-0, P3 needle, 12/box	N50P3
	Silk 3-0, FS-2 needle, 12/box	S30FS2

All prices are available in the product section of our website. Volume discounts are available for some items.

Blue Sky Bio is not affiliated with Nobel Biocare.

Blue Sky Bio's products are not manufactured, endorsed, or warranted by Nobel.

** BIO | Max implants are not compatible with Nobel Biocare Gold Adapt non-engaging UCLA abutments.

Master Bone Expander Kit

Master Bone Expander Kit includes the Bone Expander Kit and four Lerner Ridge Splitting Chisels.

Master Bone Expander Kit



Size	Part #
Master Bone Expander Kit	MBEK

Bone Expander Kit



Size	Part #
Bone Expander Kit	BEK

Lerner Ridge Splitting Chisels



Size	Part #
3mm Chisel with 2mm blade thickness	RSC32
3mm Chisel with .5mm blade thickness	RSC35
6mm Chisel with 2mm blade thickness	RSC62
6mm Chisel with .5mm blade thickness	RSC65

Guided Sinus Lift Kit

Guided Sinus Lift Kit



Size	Part #
Guided Sinus Lift Kit	Sinus Kit

Safety Lateral Sinus Kit

Safety Lateral Sinus Kit



Size	Part #
Safety Lateral Sinus Kit	SLSK

Guide Tubes

Guide Tubes

Size	Part #	Size	Part #
1.2 Guide Tube (5 Pack) ID=1.2mm OD=2.2mm Height=4mm Lip=1mm of total height	TUBE22-12-4L	1.9 Guide Tube (5 Pack) ID=1.9mm OD=2.9mm Height=4mm Lip=1mm of total height	TUBE29-19-4L
1.4 Guide Tube (5 Pack) ID=1.4mm OD=2.4mm Height=4mm Lip=1mm of total height	TUBE24-14-4L	2.0 Guide Tube (5 Pack) ID=2.0mm OD=3.0mm Height=4mm Lip=1mm of total height	TUBE3-2-4L

All prices are available in the product section of our website. Volume discounts are available for some items.

Blue Sky Bio is not affiliated with Nobel Biocare.

Blue Sky Bio's products are not manufactured, endorsed, or warranted by Nobel.

** BIO | Max implants are not compatible with Nobel Biocare Gold Adapt non-engaging UCLA abutments.

Guide Tubes

Size	Part #	Size	Part #
1.55 Guide Tube (5 Pack) ID=1.55mm OD=2.55mm Height=7mm		2.0 Guide Tube (5 Pack) ID=2.0mm OD=3.0mm Height=5mm Lip=1mm of total height	Tube20
1.6 Guide Tube (5 Pack) ID=1.6mm OD=2.6mm Height=4mm Lip=1mm of total height	TUBE26-16-4L	2.1 Guide Tube (5 Pack) ID=2.1mm OD=3.1mm Height=4mm Lip=1mm of total height	TUBE31-21-4L
1.7 Guide Tube (5 Pack) ID=1.7mm OD=2.7mm Height=4mm Lip=1mm of total height	TUBE27-17-4L	2.1 Guide Tube ID=2.1mm OD=3.0mm Height=5mm Lip=1mm of total height	TUBE3-21-5L
2.1 Guide Tube ID=2.1mm OD=4.0mm Height=5mm Lip=1mm of total height	TUBE4-21-5L	2.4 Guide Tube (5 Pack) ID=2.4mm OD=3.4mm Height=4mm Lip=1mm of total height	TUBE34-24-4L
2.1 Guide Tube ID=2.1mm OD=5.0mm Height=5mm Lip=1mm of total height	TUBE5-21-5L	2.4 Guide Tube ID=2.4mm OD=4.0mm Height=5mm Lip High=1mm of total height Lip Wide=.5mm	TUBE4-24-5L
2.11 Guide Tube (5 Pack) ID=2.11mm OD=3.11mm Height=5mm Lip=1mm of total height	Tube211	2.4 Guide Tube ID=2.4mm OD=3.0mm Height=5mm Lip=1mm of total height	TUBE3-24-5L
2.2 Guide Tube (5 Pack) ID=2.2mm OD=3.2mm Height=5mm Lip=1mm of total height	Tube22	2.4 Guide Tube ID=2.4mm OD=5.0mm Height=5mm Lip=1mm of total height	TUBE5-24-5L
2.3 Guide Tube ID=2.3mm OD=3.0mm Height=5mm Lip=1mm of total height	TUBE3-23-5L	2.1 Guide Tube ID=2.1mm OD=3.0mm Height=5mm Lip=1mm of total height	TUBE4-26-5L
2.3 Guide Tube ID=2.3mm OD=4.0mm Height=5mm Lip High=1mm of total height Lip Wide=.5mm	TUBE4-23-5L	2.72 Guide Tube ID=2.72mm OD=4.4mm Height=5mm Lip=1mm of total height	TUBE44-272
2.3 Guide Tube ID=2.3mm OD=5.0mm Height=5mm Lip=1mm of total height	TUBE5-23-5L	2.8 Guide Tube (5 Pack) ID=2.8mm OD=3.8mm Height=5mm Lip=1mm of total height	TUBE280

All prices are available in the product section of our website. Volume discounts are available for some items.

Blue Sky Bio is not affiliated with Nobel Biocare.

Blue Sky Bio's products are not manufactured, endorsed, or warranted by Nobel.

** BIO | Max implants are not compatible with Nobel Biocare Gold Adapt non-engaging UCLA abutments.

Guide Tubes

Size	Part #	Size	Part #
2.31 Guide Tube (5 Pack) ID=2.31mm OD=3.31mm Height=5mm Lip=1mm of total height	Tube231	2.8 Guide Tube ID=2.8mm OD=4.0mm Height=5mm Lip=1mm of total height	TUBE4-28-5L
2.8 Guide Tube ID=2.8mm OD=5.0mm Height=5mm Lip=1mm of total height	TUBE5-28-5L	3.3 Guide Tube ID=3.3mm OD=5.0mm Height=5mm Lip=1mm of total height	TUBE5-33-5L
2.9 Guide Tube ID=2.9mm OD=4.0mm Height=5mm Lip=1mm of total height	TUBE4-29-5L	3.5 Guide Tube ID=3.5mm OD=4.0mm Height=5mm Lip=1mm of total height	TUBE4-35-5L
2.9 Guide Tube ID=2.9mm OD=5.0mm Height=5mm Lip=1mm of total height	TUBE5-29-5L	3.5 Guide Tube ID=3.5mm OD=5.0mm Height=5mm Lip=1mm of total height	TUBE5-35-5L
2.9 Guide Tube ID=2.9mm OD=5.0mm Height=5mm Lip=1mm of total height	TUBE5-29-5L	3.6 Guide Tube ID=3.6mm OD=4.0mm Height=5mm Lip=1mm of total height	TUBE4-36-5L
2.92 Guide Tube (5 Pack) ID=2.92mm OD=3.92mm Height=5mm Lip=1mm of total height	TUBE292	3.68 Guide Tube (5 Pack) 3.5mm Short/Long, Bio Trilobe ID=3.68mm OD=4.68mm Height=5mm Lip=1mm of total height	TUBE368
3.0 Guide Tube ID=3.0mm OD=5.0mm Height=5mm Lip=1mm of total height	TUBE5-3-5L	3.75 Guide Tube ID=3.75mm OD=4.4mm Height=5mm Lip=1mm of total height	TUBE44-375
3.15 Guide Tube ID=3.15mm OD=4.4mm Height=5mm Lip=1mm of total height	TUBE44-315	3.79 Guide Tube ID=3.79mm OD=4.4mm Height=5mm Lip=1mm of total height	TUBE44-379
3.3 Guide Tube ID=3.3mm OD=4.0mm Height=5mm Lip=1mm of total height	TUBE4-33-5L	3.9 Guide Tube ID=3.9mm OD=5.0mm Height=5mm Lip=1mm of total height	TUBE5-39-5L
4.1 Guide Tube ID=4.1mm OD=5.0mm Height=4mm Lip=1mm of total height	TUBE5-41-4L	4.45 Guide Tube (5 Pack) 4.3mm Short / Long, Bio Trilobe ID=4.45mm OD=5.45mm	TUBE445

All prices are available in the product section of our website. Volume discounts are available for some items.

Blue Sky Bio is not affiliated with Nobel Biocare.

Blue Sky Bio's products are not manufactured, endorsed, or warranted by Nobel.

** BIO | Max implants are not compatible with Nobel Biocare Gold Adapt non-engaging UCLA abutments.

Guide Tubes

Size	Part #	Size	Part #
4.1 Guide Tube (5 Pack) ID=4.1mm OD=5.1mm Height=3.5mm Lip=1mm of total height	TUBE51-41-35L	4.52 Guide Tube ID=4.52mm OD=5.57mm Height=4mm Lip=1mm of total height	TUBE557-452-4L
4.15 Guide Tube (5 Pack) ID=4.15mm OD=5.15mm Height=5mm Lip=1mm of total height	TUBE415	4.68 Guide Tube ID=4.68mm OD=5.3mm Height=5mm Lip=1mm of total height	TUBE53-468
4.2 Guide Tube ID=4.2mm OD=5.0mm Height=4.5mm Lip=1mm of total height	TUBE5-42-45L	4.7 Guide Tube (5 Pack) ID=4.7mm OD=5.7mm Height=4mm Lip=1mm of total height	TUBE57-47-4L
4.25 Guide Tube (5 Pack) ID=4.25mm OD=5.25mm Height=4mm Lip=1mm of total height	TUBE525-425-4L	5.0 Guide Tube (5 Pack) ID=5.0mm OD=6.0mm Height=3.5mm Lip=1mm of total height	TUBE6-5-35L
4.25 Guide Tube (5 Pack) ID=4.25mm OD=5.25mm Height=5mm Lip=1mm of total height	TUBE425	5.0 Guide Tube ID=5.0mm OD=6.2mm Height=4mm Lip=1mm of total height	TUBE62-5-4L
4.25 Guide Tube ID=4.25mm OD=5.3mm Height=5mm Lip=1mm of total height	TUBE53-425	5.02 Guide Tube (5 Pack) ID=5.02mm OD=6.02mm Height=5mm Lip=1mm of total height	TUBE502
4.35 Guide Tube ID=4.35mm OD=5.27mm Height=6mm Lip=1mm of total height	TUBE527-435-6L	5.06 Guide Tube (5 Pack) ID=5.06mm OD=6.02mm Height=3.5mm Lip=1mm of total height	TUBE6-506-35L
5.08 Guide Tube (5 Pack) ID=5.08mm OD=6.08mm Height=5mm Lip=1mm of total height	TUBE508	5.5 Guide Tube ID=5.5mm OD=6.5mm Height=4mm Lip=1mm of total height	TUBE65-55-4L
5.1 Guide Tube ID=5.1mm OD=6.1mm Height=6mm Lip=1mm of total height	TUBE61-51-6L	5.7 Guide Tube (5 Pack) ID=5.7mm OD=6.7mm Height=4mm Lip=1mm of total height	TUBE67-57-4L
5.15 Guide Tube (5 Pack) ID=5.15mm OD=6.15mm Height=4mm Lip=1mm of total height	TUBE615-515-4L	6.13 Guide Tube ID=6.13mm OD=6.95mm Height=3.2mm Lip=1mm of total height	TUBE695-613-32L

All prices are available in the product section of our website. Volume discounts are available for some items.

Blue Sky Bio is not affiliated with Nobel Biocare.

Blue Sky Bio's products are not manufactured, endorsed, or warranted by Nobel.

** BIO | Max implants are not compatible with Nobel Biocare Gold Adapt non-engaging UCLA abutments.

Guide Tubes

Size	Part #	Size	Part #
5.15 Guide Tube (5 Pack) ID=5.15mm OD=6.15mm Height=4mm Lip=1mm of total height	TUBE615-515-4L	6.13 Guide Tube ID=6.13mm OD=6.95mm Height=3.2mm Lip=1mm of total height	TUBE695-613-32L
5.16 Guide Tube (5 Pack) 5.0mm Short, Bio Trilobe ID=5.16mm OD=6.16mm Height=5mm Lip=1mm of total height	TUBE516	6.2 Guide Tube ID=6.2mm OD=6.9mm Height=4mm Lip=1mm of total height	TUBE69-62-4L
5.25 Guide Tube (5 Pack) ID=5.25mm OD=6.25mm Height=4mm Lip=1mm of total height	TUBE625-525-4L	6.2 Guide Tube (5 Pack) ID=6.2mm OD=7.2mm Height=3.5mm Lip=1mm of total height	TUBE72-62-35L
5.25 Guide Tube (5 Pack) ID=5.25mm OD=6.25mm Height=5mm Lip=1mm of total height	TUBE525	6.26 Guide Tube (5 Pack) ID=6.26mm OD=7.21mm Height=3.5mm Lip=1mm of total height	TUBE72-626-35L
5.31 Guide Tube ID=5.31mm OD=6.2mm Height=4.5mm Lip=1mm of total height	TUBE62-531-45L	6.3 Guide Tube ID=6.3mm OD=7.3mm Height=6mm Lip=1mm of total height	TUBE73-63-6L
5.35 Guide Tube (5 Pack) ID=5.35mm OD=6.35mm Height=4mm Lip=1mm of total height	TUBE635-535-4L	6.72 Guide Tube ID=6.72mm OD=7.17mm Height=5mm Lip=1mm of total height	TUBE717-672

All prices are available in the product section of our website. Volume discounts are available for some items.

Blue Sky Bio is not affiliated with Nobel Biocare.

Blue Sky Bio's products are not manufactured, endorsed, or warranted by Nobel.

** BIO | Max implants are not compatible with Nobel Biocare Gold Adapt non-engaging UCLA abutments.

Terms and Conditions

Blue Sky Bio, LLC - TERMS AND CONDITIONS – Important User Information

Blue Sky Bio offers high quality dental implant products at much lower prices, compared to its competitors. To help keep our overhead low and prices value-minded, we only accept returns or exchanges under *very limited circumstances*.

RETURNS & EXCHANGES

Blue Sky Bio will accept returns or exchanges within 30 days of original sales receipt. Products returned or exchanged between 31 and 120 days of original sales receipt are subject to a 15% restocking fee. No products can be returned or exchanged after 120 days from date of original sales receipt. Prior to return or exchange please contact us for a Return Authorization Number (RA#). All returned or exchanged products are subject to inspection. Products that have been opened, damaged or marked upon are not eligible for return or exchange. When your products arrive, inspect the packaging and the contents for damage and defects. You must notify us within 7 days from date of original sales receipt if, product packaging is damaged, illegible, or has a broken safety seal; or if product itself appears to be damaged or does not function as its intended use. In these cases, Blue Sky Bio will pay return shipping charges, and will pay shipping charges of replacement products. Blue Sky Bio does not offer a credit or reimburse for implants that do not integrate.

ORDER PLACEMENT

Blue Sky Bio accepts payment for purchases with Visa, MasterCard, and American Express, through its secure website or in limited circumstances, with our fax order form. Prices for products, sales tax, shipping, or any other charges will be listed on your sales receipt. Full payment is due before orders are shipped. Sales are final after shipment has left our distribution center. Blue Sky Bio reserves the right to hold orders until credit card information can be confirmed. You may be contacted by a Blue Sky Bio representative regarding your purchase.

SHIPPING

Orders placed within the United States are shipped via UPS. Orders placed outside the United States are shipped via Fedex. Customers are ultimately responsible to ensure that carriers will deliver at the requested time in their areas. Orders placed before 1:30pm CST will ship the same day. Orders placed after 1:30pm CST may not ship until the next business day. Blue Sky Bio recognizes holidays throughout the year. Watch our home page for notices regarding company closings due to holidays and shipping delays due to weather..

INTERNATIONAL BROKER / TAX TERMS

Blue Sky Bio utilizes Fedex Express (FE) to ship and broker all orders from the United States to your door. As broker, FE pays all taxes, tariffs, and VAT due on shipments. FE will bill you separately for these charges after you receive your order, including their broker fee. Taxes and broker fees are not part of your shipping charge collected at time of order. By placing your order you authorize Blue Sky Bio to collect any taxes not paid, as soon as reported by FE of tax delinquency, via your credit card on file. You will be responsible for any additional charges or late fees associated with not paying responsible taxes, tariffs, and VAT promptly.

CONTACTING BLUE SKY BIO

Contacting us is very easy and convenient. Call us toll-free 9am – 5pm CST at, **888-446-6724**, or email us anytime at, info@blueskybio.com.

IMPORTANT PRODUCT NOTICES FOR BLUE SKY BIO CUSTOMERS

BIO | Max is NobelActive® compatible.

BIO | Max implants are not compatible with Nobel Biocare Gold Adapt non-engaging UCLA abutments.

Blue Sky Bio is not affiliated with Nobel Biocare®. NobelActive® is a registered trademark of Nobel Biocare.