

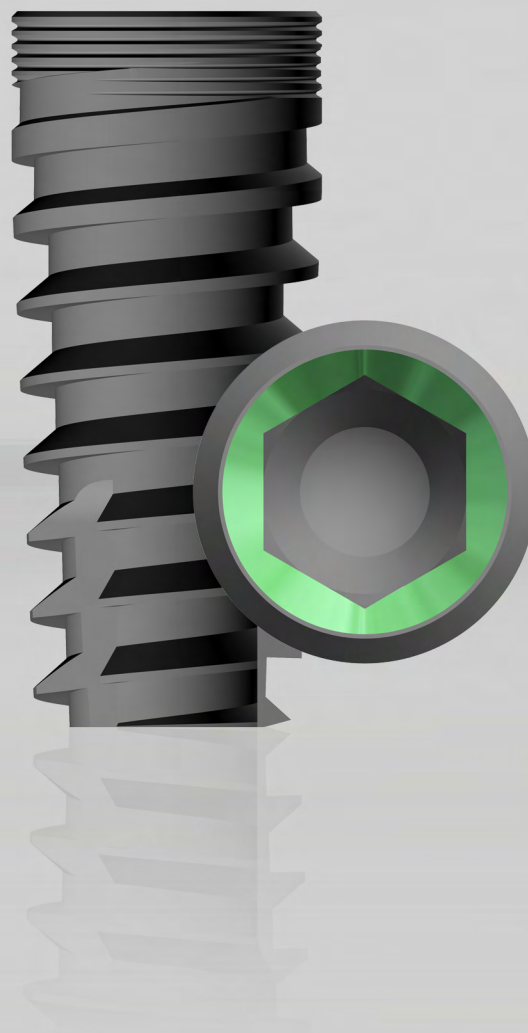

**BlueSkyBio**

**Your Partner In Digital Dentistry**

**BIO | Internal Hex**



**2020**

**Product Catalog**

**BIO | Internal Hex**

Zimmer Tapered Screw Vent® Compatible

January 2020

# Table of contents

<b>Implant Packs</b>	<b>2</b>
<b>Practice Building Kits</b>	<b>2,3</b>
<b>Healing Abutments</b>	<b>3</b>
<b>MPA Custom Abutments</b>	<b>4</b>
<b>Angled Abutments</b>	<b>4</b>
<b>KISS Abutments</b>	<b>4,5</b>
<b>Gold Castable Abutments</b>	<b>5</b>
<b>Plastic Castable Abutments</b>	<b>5</b>
<b>Multi Unit Abutments</b>	<b>6</b>
<b>Temporary Abutments</b>	<b>6</b>
<b>Digital Abutments</b>	<b>7</b>
<b>Intraoral Scanning Parts</b>	<b>7</b>
<b>Overdenture Abutments</b>	<b>7</b>
<b>Angled Overdenture Abutments</b>	<b>8</b>
<b>Analog</b>	<b>9</b>
<b>Impression Transfers</b>	<b>9</b>
<b>Surgical Instruments</b>	<b>9,10</b>

<b>Internal Hex Drill Taps</b>	<b>10</b>
<b>Safety Stop Surgical Kit</b>	<b>11,12</b>
<b>Fully Guided Keyless Kit</b>	<b>12,13</b>
<b>Hammerless Crestal Sinus Lift Kit</b>	<b>14</b>
<b>BIO   BlueTouch</b>	<b>14</b>
<b>Suture</b>	<b>14</b>
<b>Master Bone Expander Kit</b>	<b>15</b>
<b>Guided Sinus Lift Kit</b>	<b>15</b>
<b>Safety Lateral Sinus Kit</b>	<b>15</b>
<b>Guide Tubes</b>	<b>15-18</b>
<b>Terms &amp; Conditions</b>	<b>19</b>

# Implant Packs

- Packs include Internal Hex implant, 1 mm cover screw and a 3mm healing abutment
- Blue Sky Bio Internal Hex implants are fully compatible with Zimmer Dental's Tapered Screw Vent® implant system.

## 3.7mm Implant - 3.5mm Platform

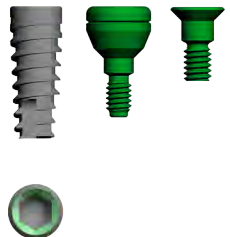

Size	Part #
8mm	IH3708
10mm	IH3710
11.5mm	IH3711
13mm	IH3713
16mm	IH3716

## 4.1mm Implant - 3.5mm Platform

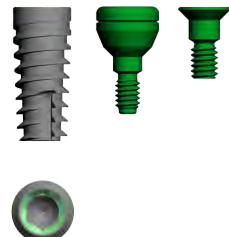

Size	Part #
8mm	IH4108
10mm	IH4110
11.5mm	IH4111
13mm	IH4113
16mm	IH4116

## 4.7mm Implant - 3.5mm Platform Switched

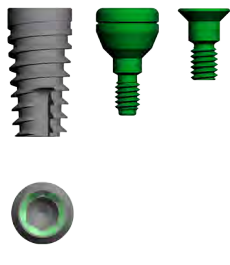

Size	Part #
6mm	IHPS4706
8mm	IHPS4708
10mm	IHPS4710
11.5mm	IHPS4711
13mm	IHPS4713
16mm	IHPS4716

## 4.7mm Implant - 4.5mm Platform

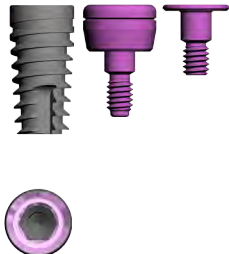

Size	Part #
8mm	IH4708
10mm	IH4710
11.5mm	IH4711
13mm	IH4713
16mm	IH4716

## 5.7mm Implant - 4.5mm Platform Switched

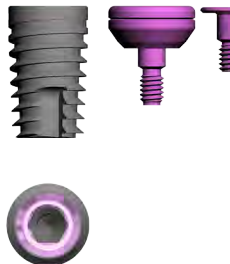

Size	Part #
6mm	IH5708
8mm	IH5708
10mm	IH5710
11.5mm	IH5711
13mm	IH5713
16mm	IH5716

## 7.0mm Implant - 4.5mm Platform Switched



Size	Part #
6mm	IH7008
8mm	IH7008
10mm	IH7010
11.5mm	IH7011

# Practice Building Kits

- Kits include Internal Hex implant, 1 mm cover screw, 3mm abutment, final abutment/implant level impression coping, and implant level analog
- MPA Multi Purpose Abutments: Abutments can be used as an implant level impression transfer and the final abutment.
- Blue Sky Bio Internal Hex implants are fully compatible with Zimmer Dental's Tapered Screw Vent® implant system.

## 3.7mm Practice Building Kit - 3.5mm Platform

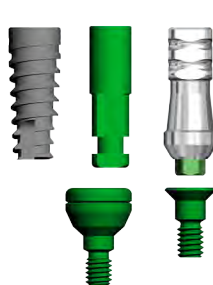

Size	Part #
8mm	KZPACTA3708
10mm	KZPACTA3710
11.5mm	KZPACTA3711
13mm	KZPACTA3713
16mm	KZPACTA3716

## 4.1mm Practice Building Kit - 3.5mm Platform

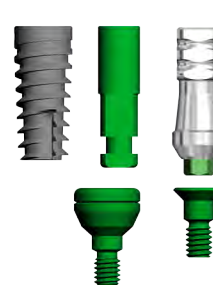

Size	Part #
8mm	KZPACTA4108
10mm	KZPACTA4110
11.5mm	KZPACTA4111
13mm	KZPACTA4113
16mm	KZPACTA4116

All prices are available in the product section of our website. Volume discounts are available for some items.  
Blue Sky Bio is not affiliated with Zimmer Dental®.



### 4.7mm Practice Building Kit - 3.5mm Platform Switched

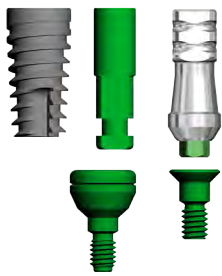

Size	Part #
6mm	KZPACTAPS4706
8mm	KZPACTAPS4708
10mm	KZPACTAPS4710
11.5mm	KZPACTAPS4711
13mm	KZPACTAPS4713
16mm	KZPACTAPS4716

### 4.7mm Practice Building Kit - 4.5mm Platform

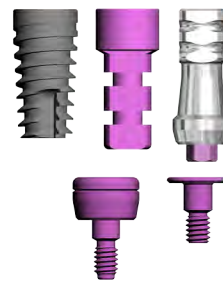

Size	Part #
8mm	KZPACTA4708
10mm	KZPACTA4710
11.5mm	KZPACTA4711
13mm	KZPACTA4713
16mm	KZPACTA4716

### 5.7mm Practice Building Kit - 4.5mm Platform

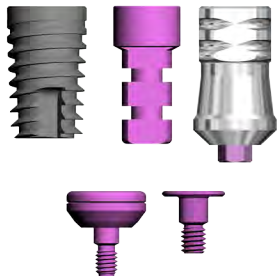

Size	Part #
6mm	KZPACTA5706
8mm	KZPACTA5708
10mm	KZPACTA5710
11.5mm	KZPACTA5711
13mm	KZPACTA5713
16mm	KZPACTA5716

### 5.7mm Practice Building Kit - 4.5mm Platform

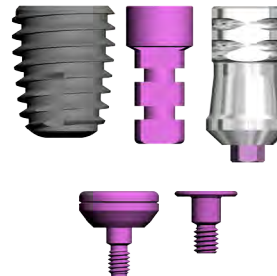

Size	Part #
6mm	KZPACTA5706
8mm	KZPACTA5708
10mm	KZPACTA5710
11.5mm	KZPACTA5711
13mm	KZPACTA5713
16mm	KZPACTA5716

## Healing Abutments and Cover Screws

Blue Sky Bio Internal Hex implants are fully compatible with Zimmer Dental's Tapered Screw Vent® implant system.

### 3.5 Platform Healing Abutment



Size	Part #
3.5 Platform - 3mm height	HH3530



3.5 Platform - 5mm height	HH3550
---------------------------	--------

### 4.5 Platform Healing Abutment



Size	Part #
4.5 Platform - 5mm height	HH4530



4.5 Platform - 5mm height	HH4550
---------------------------	--------

### 3.5 Platform Healing Abutment



Size	Part #
4.7mm 3.5 Platform - 3mm height	HH354730



4.7mm 3.5 Platform - 5mm height	HH354750
---------------------------------	----------



4.7mm 3.5 Platform - 5mm height	HH356550
---------------------------------	----------



4.7mm 3.5 Platform - 5mm height	HH356550
---------------------------------	----------



Cover Screw 3.5mm Platform	CH3500
----------------------------	--------

### 4.5 Platform Healing Abutment



Size	Part #
6.5mm 4.5 Platform - 3mm height	HH456530



6.5mm 4.5 Platform - 5mm height	HH456550
---------------------------------	----------



Cover Screw 3.5mm Platform	CH3500
----------------------------	--------

All prices are available in the product section of our website. Volume discounts are available for some items. Blue Sky Bio is not affiliated with Zimmer Dental®.

## MPA Custom Abutments

- Kits include MPA Abutment, Analog, and Fixation Screw.
- MPA Multi Purpose Abutments: Abutments can be used as an implant level impression transfer and the final abutment. Blue Sky Bio Internal Hex implants are fully compatible with Zimmer Dental's Tapered Screw Vent® implant system.

### 3.5 Platform Abutment



Size	Part #
3.5 MPA Abutment Analog Kit	KMPAIH3547
3.5 MPA Abutment	MPAIH3547
3.5 Implant Level Analog	BIH35

### 4.5 Platform Wide Abutment

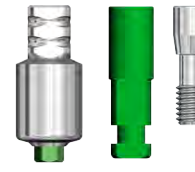

Size	Part #
3.5 MPA Wide Abutment Analog Kit	KMPAIH3560
3.5 MPA Wide Abutment	MPAIH3560
3.5 Implant Level Analog	BIH35

### 4.5 Platform Abutment



Size	Part #
4.5 MPA Abutment Analog Kit	KMPAIH4547
4.5 MPA Abutment	MPAIH4547
4.5 Implant Level Analog	BIH45

### 4.5 Platform Wide Abutment

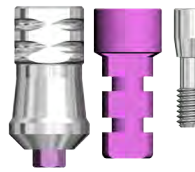

Size	Part #
4.5 MPA Wide Abutment Analog Kit	KMPAIH4565
4.5 MPA Wide Abutment	MPAIH4565
4.5 Implant Level Analog	BIH45

## Angled Abutments

- Fixation screw included
- Sky Bio Internal Hex implants are fully compatible with Zimmer Dental's Tapered Screw Vent® implant system.

### 3.5 Platform Angled Abutment



Size	Part #
Angled Abutment 15 degree	AAH3515
Angled Abutment 25 degree	AAH3525

### 4.5 Platform Angled Abutment

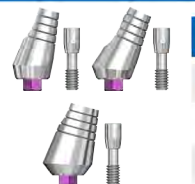

Size	Part #
Angled Abutment 15 degree	AAH4515
Angled Abutment 25 degree	AAH4525
Angled Abutment Wide 15 degree	AAH456515

## KISS Abutments

- Complete Kits include KISS abutment, screw, metal analog, two resin analogs, impression coping, engaging and non-engaging waxing sleeves and temporary sleeve.
  - Impression Kits include two resin analogs, impression coping, engaging and non-engaging waxing sleeves and temporary sleeve.
- Blue Sky Bio Internal Hex implants are fully compatible with Zimmer Dental's Tapered Screw Vent® implant system.

All prices are available in the product section of our website. Volume discounts are available for some items.  
Blue Sky Bio is not affiliated with Zimmer Dental®.

### 3.5 Platform Regular KISS



Size	Part #
3.5 Regular KISS Abutment 1mm collar	ASIH35R01

### 4.5 Platform Regular KISS



Size	Part #
4.5 Regular KISS Abutment 1mm collar	ASIH45R01
4.5 Regular KISS Abutment 2mm collar	ASIH45R02
4.5 Regular KISS Abutment 3mm collar	ASIH45R03

### 4.5 Platform Wide KISS



Size	Part #
4.5 Wide KISS Abutment 2mm collar	ASIH45W02

## Gold Castable Abutments

- Fixation screw included
- UCLA Abutment contains an implant level impression feature. No separate implant level impression coping is required. Blue Sky Bio Internal Hex implants are fully compatible with Zimmer Dental's Tapered Screw Vent® implant system.

#### 3.5 Platform Gold UCLA Engaging



Size	Part #
3.5 Gold UCLA Abutment	AUCLAIH35G
3.5 UCLA Abutment	BIH35
3.5 Implant Level Analog	SIH01A

#### 4.5 Platform Gold UCLA Engaging



Size	Part #
4.5 Gold UCLA Abutment	AUCLAIH45G
4.5 UCLA Abutment	BIH45
4.5 Implant Level Analog	SIH01A

#### 3.5 Platform Gold Non-Engaging UCLA



Size	Part #
3.5 Gold Non-Engaging UCLA	AUCLAIH35NG
3.5 UCLA Abutment	BIH35
3.5 Implant Level Analog	SIH01A

#### 4.5 Platform Gold Non-Engaging UCLA

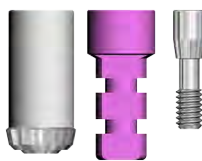

Size	Part #
4.5 Gold Non-Engaging UCLA	AUCLAIH45NG
4.5 UCLA Abutment	BIH45
4.5 Implant Level Analog	SIH01A

## Plastic Castable Abutments

#### Plastic 3.5 Platform Abutment (Engaging)



Size	Part #
3.5 Plastic Engaging UCLA	PAUCLAIH35

#### Plastic 4.5 Platform Abutment (Engaging)



Size	Part #
4.5 Plastic Engaging UCLA	PAUCLAIH45

#### Plastic 3.5 Platform Abutment (Non-Engaging)



Size	Part #
3.5 Plastic Non-Engaging UCLA	PAUCLAIH35N

#### Plastic 4.5 Platform Abutment (Non-Engaging)







Size	Part #
4.5 Plastic Non-Engaging UCLA	PAUCLAIH45N





All prices are available in the product section of our website. Volume discounts are available for some items. Blue Sky Bio is not affiliated with Zimmer Dental®.

# Multi Unit Abutments













## 3.5 Platform

Size	Part #
 Abutment Multi Unit Straight, 3.5 platform, Internal Hex, 1.5mm cuff - Requires .080 Hex Driver	AMUSIH3515
 Abutment Multi Unit Straight, 3.5 platform, Internal Hex, 3.0mm cuff - Requires .080 Hex Driver	AMUSIH3530
 Abutment Multi Unit Straight, 3.5 platform, Internal Hex, 5.0mm cuff - Requires .080 Hex Driver	AMUSIH3550
 Angled Abutment Multi Unit, 3.5 platform, 17 degree, Internal Hex, includes abutment screw	AAMUIH3517
 Angled Abutment Multi Unit, 3.5 platform, 30 degree, Internal Hex, includes abutment screw	AAMUIH3530

## 4.5 Platform

Size	Part #
 Abutment Multi Unit Straight, 4.5 platform, Internal Hex, 1.5mm cuff - Requires .080 Hex Driver	AMUSIH4515
 Abutment Multi Unit Straight, 4.5 platform, Internal Hex, 3.0mm cuff - Requires .080 Hex Driver	AMUSIH4530
 Abutment Multi Unit Straight, 4.5 platform, Internal Hex, 5.0mm cuff - Requires .080 Hex Driver	AMUSIH4550
 Angled Abutment Multi Unit, 4.5 platform, 17 degree, Internal Hex, includes abutment screw	AAMUIH4517
 Angled Abutment Multi Unit, 4.5 platform, 30 degree, Internal Hex, includes abutment screw	AAMUIH4530

## Components

Size	Part #	Size	Part #
 Comfort Cap for all Multi Unit Abutments	CMU	 MMUTC Casting Sleeve	PWAXMUTC
 Combination Impression Transfer, Temporary Abutment and Castable Sleeve, Plastic - Requires screw SMUS or SMUL	MMUP	 Analog, Multi Unit	BMU
 Combination Impression Transfer/ Temporary Abutment - Titanium Alloy - Requires screw SMUS or SMUL	MMUT	 Angled Multi Unit Abutment Delivery Aid	DSMU
 Multiunit Coping, Temporary Abutment Titanium Alloy - Requires screw SMUS or SMUL	MMUTC	 Screw Multi Unit Impression Transfer, long	SMUL
 Multi Unit Titanium Coping Thimble	MUT	 Screw, Multi Unit, Castable Abutments, short	SMUS
 MMUTC Spacer Sleeve	PSPACEMUTC	 .080 Hex Driver for straight Multi Unit Abutments	HFD

# Temporary Abutment

## 3.5 Platform Abutment

Size	Part #
 Digital Abutment for temporary abutment (includes abutment screw)	ABIH35
Additional Abutment Screw	SIH01A

## 4.5 Platform Abutment

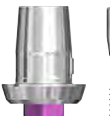
Size	Part #
 Digital Abutment for temporary abutment (includes abutment screw)	ABIH45
Additional Abutment Screw	SIH01A

All prices are available in the product section of our website. Volume discounts are available for some items. Blue Sky Bio is not affiliated with Zimmer Dental®.



# Digital Abutment

## 3.5 Platform Abutment

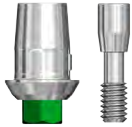

Size	Part #
Digital Abutment for abutment and crowns for zirconia and emax (includes fixation screw)	ABIH35
Additional Abutment Screw	SIH01A

## 4.5 Platform Abutment



Size	Part #
Digital Abutment for abutment and crowns for zirconia and emax (includes fixation screw)	ABIH45
Additional Abutment Screw	SIH01A

# Intraoral Scanning Parts

## Master Overdenture Restorative Kits Regular - Chairside

Size	Part #
Rosetta Scanpost Extender for Regular Digital Abutments	OPTIBASER
Regular Ball ScanSnap (required for Exocad or 3Shape)	BALL6
Rosetta Scanpost Extender for Mini Digital Abutments	OPTIBASEN

## Master Overdenture Restorative Kits Regular - Laboratory

Size	Part #
Mini Ball ScanSnap (required for Exocad / 3Shape)	BALL6MI
ScanFlag Scanpost for Regular Digital Abutments	OPTICSTB
ScanFlag Scanpost for Mini Digital Abutments	OPTICSTBMI

# Overdenture Abutments

Super Snap Overdenture Restorative Kit – Chairside includes: overdenture abutment, retention inserts and block out ring.

Super Snap Overdenture Restorative Kit – Laboratory includes: overdenture abutment, retention inserts, block out ring, analog and impression transfer.

## Super Snap Overdenture Restorative Kits 3.5- Chairside

Size	Part #
Super Insert Restorative Kits - Chairside, 3mm	SIRKIH3530
Super Insert Restorative Kits - Chairside, 5mm	SIRKIH3550

## Super Snap Overdenture Restorative Kits 3.5 - Laboratory

Size	Part #
Super Insert Restorative Kits - Laboratory, 3mm	SIRKIH3530-L
Super Insert Restorative Kits - Laboratory, 5mm	SIRKIH3550-L

## Super Snap Overdenture Restorative Kits 4.5 - Chairside

Size	Part #
Super Insert Restorative Kits - Chairside, 3mm	SIRKIH4530
Super Insert Restorative Kits - Chairside, 5mm	SIRKIH4550

## Super Snap Overdenture Restorative Kits 4.5 - Laboratory

Size	Part #
Super Insert Restorative Kits - Laboratory, 3mm	SIRKIH4530-L
Super Insert Restorative Kits - Laboratory, 5mm	SIRKIH4550-L

All prices are available in the product section of our website. Volume discounts are available for some items.

Blue Sky Bio is not affiliated with Zimmer Dental®.

# Angled Overdenture Abutments

## Super Snap Overdenture Restorative Kits 3.5- Chairside

Size	Part #
 Angled Super Overdenture Restorative Kit 3.5 Platform, 17 degrees	ASRKIH3517

 Angled Super Overdenture Restorative Kit 3.5 Platform, 30 degrees	ASRKIH3530
--	------------

## Super Snap Overdenture Restorative Kits 3.5 - Laboratory

Size	Part #
 Angled Super Overdenture Restorative Kit 3.5 Platform, 30 degrees	ASRKIH3517-L

 Angled Super Overdenture Restorative Kit 3.5 Platform, 30 degrees	ASRKIH3530-L
--	--------------

## Super Snap Overdenture Restorative Kits 4.5 - Chairside

Size	Part #
 Angled Super Overdenture Restorative Kit 4.5 Platform, 17 degrees	ASRKIH4517





 Angled Super Overdenture Restorative Kit 4.5 Platform, 17 degrees	ASRKIH4530
---	------------

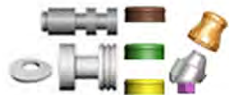



## Super Snap Overdenture Restorative Kits 4.5 - Laboratory

Size	Part #
 Angled Super Overdenture Restorative Kit 4.5 Platform, 17 degrees	ASRKIH4517-L

 Angled Super Overdenture Restorative Kit 4.5 Platform, 17 degrees	ASRKIH4530-L
---	--------------

## Overdenture Products

	Size	Part #
 Complete Flat Snap Restorative Kit		NOPK
 Analog		FSA
 Replacement Inserts Strong Retention (4 Pack)		FSCS
 Replacement Inserts Medium / Light Retention (4 Pack)		FSCG
 Resin Impression transfer (2 Pack) and FSCB (4 Pack)		FSCR
 Processing Inserts No Retention (4 Pack)		FSCB
 Super Insert – Strong retention, requires no housing (includes 2 inserts and 2 block out rings) <b>Extreme long lasting retention on parallel implants.</b>		FOPS
 Super Insert – Medium retention, requires no housing (includes 2 inserts and 2 block out rings) <b>Extreme long lasting retention on parallel implants.</b>		FOPG

	Size	Part #
 Super Insert – Light retention, requires no housing (includes 2 inserts and 2 block out rings) <b>Extreme long lasting retention on parallel implants.</b>		FOPR
 Resin Impression transfer (2 Pack)		FSI
 Titanium Housing		HGFS
 Block Out Ring (10 Pack)		RSD01
 Insert Placement/Removal Instrument		TFSU
 Insert Placement/Removal Instrument		TFSU

All prices are available in the product section of our website. Volume discounts are available for some items. Blue Sky Bio is not affiliated with Zimmer Dental®.

# Analogs

## Implant Level Analogs

Size	Part #	Size	Part #
 3.5 Implant Level Analog	BIH35	 4.5 Implant Level Analog	BIH45

# Impression Transfers

## Implant Level Impression Transfers

Size	Part #	Size	Part #
 3.5 Implant Level Impression Transfer	MIH3500	 4.5 Implant Impression Transfer	MIH4500

# Surgical Instruments















Blue Sky Bio Internal Hex implants are fully compatible with Zimmer Dental's Tapered Screw Vent® implant system.

## Surgical Instruments





Size	Part #
	Torque/Ratchet Wrench TR-900-01
	.050 Hex Driver Short HTT
	.050 Hex Driver Long HTLT
	Handpiece Implant Driver Short DMSIH
	Handpiece Implant Driver Long DMLIH
	Ratchet Implant Driver Short DTSIH
	Ratchet Implant Driver Long DTLIH
	Thumb Knob for Drivers TK
	Starter Drill Short DRILLNSS
	Starter Drill Long DRILLNSL
	Drill 2.2mm Short DRILLN22S
	Drill 2.2mm Long DRILLN22L
	Final Drill for the 3.7mm Implant, short DRILLN35S

All prices are available in the product section of our website. Volume discounts are available for some items. Blue Sky Bio is not affiliated with Zimmer Dental®.

## Surgical Instruments







	Size	Part #
	Final Drill for the 3.7mm Implant, long	DRILLN35L
	Profile Drill for the 3.7mm Implant	DRILLPH37
	Final Drill for the 4.1mm Implant, short	DRILL3630S
	Final Drill for the 4.1mm Implant, long	DRILL3630L
	Profile Drill for the 4.1mm Implant	DRILLPH41
	Final Drill for the 4.7mm Implant, short	DRILL4438S
	Final Drill for the 4.7mm Implant, long	DRILL4438L
	Profile Drill for the 4.7mm Implant	DRILLPH47
	Final Drill for the 5.7mm Implant, short	DRILLH53S
	Final Drill for the 5.7mm Implant, long	DRILLH53L
	Profile Drill for the 5.7mm Implant	DRILLPH57
	Final Drill for the 7.0mm Implant, short	DRILL6653S
	Profile Drill for the 7.0mm Implant	DRILLPH70
	Instrument Box	IHIB
	Internal Hex Complete Surgical Kit	IHCSK

## Internal Hex Drill Taps

	Size	Part #
	Tap 3.7mm	TAPH37
	Tap 4.1mm	TAPH41
	Tap 4.7mm	TAPH47
	TAP 5.7mm	TAPH57

All prices are available in the product section of our website. Volume discounts are available for some items.  
Blue Sky Bio is not affiliated with Zimmer Dental®.

















	Size	Part #
	Lindemann Bur	LINDR-S21
	Lance Drillt	LD150
	Trepine Bur	TPHB-B6
	Final Drill for 7.0mm Implant, short	DRILL6653S
	Angled Screw Driver (20Ncm max torque)	SDUGA
	Screw Removal Tool	AFSR

## Safety Stop Surgical Kit



	Part #
Safety Stop Surgical Kit	SSSMNP

### Safety Stop Kit Individual Components And Accessories

	Size	Part #
	Drill Stop 2.0 x 6mm	DRILNSTP2006
	Drill Stop 2.0 x 8mm	DRILNSTP2008
	Drill Stop 2.0 x 10mm	DRILNSTP2010
	Drill Stop 2.0 x 11.5mm	DRILNSTP2011
	Drill Stop 2.0 x 13mm	DRILNSTP2013
	Drill Stop 2.5 x 6mm	DRILNSTP2506
	Drill Stop 2.5 x 8mm	DRILNSTP2508
	Drill Stop 2.5 x 10mm	DRILNSTP2510
	Drill Stop 2.5 x 11.5mm	DRILNSTP2511
	Drill Stop 2.5 x 13mm	DRILNSTP2513
	Drill Stop 3.0 x 6mm	DRILNSTP3006
	Drill Stop 3.0 x 8mm	DRILNSTP3008
	Drill Stop 3.0 x 10mm	DRILNSTP3010
	Drill Stop 3.0 x 11.5mm	DRILNSTP3011

All prices are available in the product section of our website. Volume discounts are available for some items.  
Blue Sky Bio is not affiliated with Zimmer Dental®.

### Safety Stop Kit Individual Components And Accessories



Size	Part #
Drill Stop 3.0 x 13mm	DRILNSTP3013
Drill Stop 3.6 x 6mm	DRILNSTP3606
Drill Stop 3.6 x 8mm	DRILNSTP3608
Drill Stop 3.6 x 10mm	DRILNSTP3610
Drill Stop 3.6 x 11.5mm	DRILNSTP3611
Drill Stop 3.6 x 13mm	DRILNSTP3613
Drill Stop 4.4 x 6mm	DRILNSTP4406
Drill Stop 4.4 x 8mm	DRILNSTP4408
Drill Stop 4.4 x 10mm	DRILNSTP4410
Drill Stop 4.4 x 11.5mm	DRILNSTP4411
Drill Stop 4.4 x 13mm	DRILNSTP4413
Drill Stop Drill Extender	TDE

## Fully Guided Keyless Kit





Part #	
Fully Guided Keyless Kit	GSKIH
Master Cylinder for Fully Guided Kit (Cerec M Master Tube Compatible)	TUBE524-504-4L
Master Cylinder for Fully Guided Kit (Cerec M Master Tube Compatible)	TUBE59-504-45L
Master Cylinder for Fully Guided Kit (Cerec L Master Tube Compatible)	TUBE524-504-4LNF

### Guided Kit Individual Components And Accessories



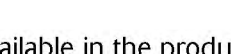

Size	Part #
Guide Drill 2.0 x 6mm	DRILG2006
Guide Drill 2.0 x 8mm	DRILG2008
Guide Drill 2.0 x 10mm	DRILG2010
Guide Drill 2.0 x 11.5mm	DRILG2011

All prices are available in the product section of our website. Volume discounts are available for some items. Blue Sky Bio is not affiliated with Zimmer Dental®.

Guided Kit Individual Components And Accessories		
	Size	Part #
	Guide Drill 2.0 x 13mm	DRILG2013
	Guide Drill 2.5 x 6mm	DRILG2506
	Guide Drill 2.5 x 8mm	DRILG2508
	Guide Drill 2.5 x 10mm	DRILG2510
	Guide Drill 2.5 x 11.5mm	DRILG2011
	Guide Drill 2.5 x 13mm	DRILG2513
	Guide Drill 3.0 x 6mm	DRILG3006
	Guide Drill 3.0 x 8mm	DRILG3008
	Guide Drill 3.0 x 10mm	DRILG3010
	Guide Drill 3.0 x 11.5mm	DRILG3011
	Guide Drill 3.0 x 13mm	DRILG3013
	Guide Drill 3.6 x 6mm	DRILG3606
	Guide Drill 3.6 x 8mm	DRILG3608
	Guide Drill 3.6 x 10mm	DRILG3610
	Guide Drill 3.6 x 11.5mm	DRILG3611
	Guide Drill 3.6 x 13mm	DRILG3613
	Guide Drill 4.4 x 6mm	DRILG4406
	Guide Drill 4.4 x 8mm	DRILG4408
	Guide Drill 4.4 x 10mm	DRILG4410
	Guide Drill 4.4 x 11.5mm	DRILG4411
	Guide Drill 4.4 x 13mm	DRILG4413
	Bone Crest Flattening Drill	DRILGFLAT
	Guided Implant Driver 8.5mm Offset	DTGIH85
	Guided Implant Driver Variable Offset	DTGIHVR
	Guide Fixation Pin (5 Pack)	PIN





All prices are available in the product section of our website. Volume discounts are available for some items.  
Blue Sky Bio is not affiliated with Zimmer Dental®.

# Hammerless Crestal Sinus Lift Kit

Sinus Lift Kit		
	Size	Part #
	Hammerless Atraumatic Crestal Sinus Lift Kit	Sinus Kit
	Addition Guide Pin	GPINMAXNP

## BIO | BlueTouch



	Size	Part #
	Touch-Screen Implant Motor (Adjustable Speed 300 – 40,000 RPM; up to 50 Ncm of torque for placement). Does not include handpiece.	BIO-BT



	Size	Part #
	Saeshin Strong 20:1 Handpiece External Irrigation (button)	ACL(B)-411
	Saeshin Traus 20:1 Non-Optic Handpiece External Irrigation (button)	CRB26XX
	Anthogyr Impulsion 20:1 Contra Angle (brush type); 50 Ncm tolerance	AHP-85P-I
	Anthogyr Mont Blanc 20:1 Contra Angle (high efficiency); 80 Ncm tolerance	AHP-85MB-X
	Anthogyr Mont Blanc 20:1 Contra Angle with Depth Control (high efficiency); 80 Ncm tolerance	AHP-85MB-CX

	Size	Part #
	Saeshin Strong 1:1 Straight Handpiece External Irrigation	AT-11
	Nozzle Clip 1:1 Straight Handpiece	ST-Nozzle
	Autoclavable Tubing Set for BIO   BlueTouch	AE-24
	Autoclavable Pump Section for AE-24 Tubing Set	AE-24-PUMP
	Synthetic Premium Handpiece Lubricant	LU1011HS
	Lubricant Tool Attachment (necessary for lubricant)	LT1013HS

## Sutures

All sutures are 60cm in length with reverse cutting needles and packaged 12 per box. Sutures sales are currently limited to U.S. customers.

	Size	Part #
	PGA Fast Resorb 4-0, FS-2 needle, 12/box	PGF40FS2
	PGA 4-0 violet, FS-2 needle, 12/box	PG40FS2
	Polypropylene (unbraided black) 5-0, P3 needle, 12/box	P50P3

	Size	Part #
	Nylon (unbraided black) 5-0, P3 needle, 12/box	N50P3
	Silk 3-0, FS-2 needle, 12/box	S30FS2

All prices are available in the product section of our website. Volume discounts are available for some items. Blue Sky Bio is not affiliated with Zimmer Dental®.



# Master Bone Expander Kit

Master Bone Expander Kit includes the Bone Expander Kit and four Lerner Ridge Splitting Chisels.

## Master Bone Expander Kit



Size	Part #
Master Bone Expander Kit	MBEK

## Bone Expander Kit



Size	Part #
Bone Expander Kit	BEK

## Lerner Ridge Splitting Chisels



Size	Part #
3mm Chisel with 2mm blade thickness	RSC32
3mm Chisel with .5mm blade thickness	RSC35
6mm Chisel with 2mm blade thickness	RSC62
6mm Chisel with .5mm blade thickness	RSC65

# Guided Sinus Lift Kit

## Guided Sinus Lift Kit



Size	Part #
Guided Sinus Lift Kit	Sinus Kit

# Safety Lateral Sinus Kit

## Safety Lateral Sinus Kit



Size	Part #
Safety Lateral Sinus Kit	SLSK

# Guide Tubes

## Guide Tubes

Size	Part #	Size	Part #
1.2 Guide Tube (5 Pack) ID=1.2mm OD=2.2mm Height=4mm Lip=1mm of total height	TUBE22-12-4L	1.9 Guide Tube (5 Pack) ID=1.9mm OD=2.9mm Height=4mm Lip=1mm of total height	TUBE29-19-4L
1.4 Guide Tube (5 Pack) ID=1.4mm OD=2.4mm Height=4mm Lip=1mm of total height	TUBE24-14-4L	2.0 Guide Tube (5 Pack) ID=2.0mm OD=3.0mm Height=4mm Lip=1mm of total height	TUBE3-2-4L

All prices are available in the product section of our website. Volume discounts are available for some items. Blue Sky Bio is not affiliated with Zimmer Dental®.

## Guide Tubes

Size	Part #	Size	Part #
2.31 Guide Tube (5 Pack) ID=2.31mm OD=3.31mm Height=5mm Lip=1mm of total height	Tube231	2.8 Guide Tube ID=2.8mm OD=4.0mm Height=5mm Lip=1mm of total height	TUBE4-28-5L
2.8 Guide Tube ID=2.8mm OD=5.0mm Height=5mm Lip=1mm of total height	TUBE5-28-5L	3.3 Guide Tube ID=3.3mm OD=5.0mm Height=5mm Lip=1mm of total height	TUBE5-33-5L
2.9 Guide Tube ID=2.9mm OD=4.0mm Height=5mm Lip=1mm of total height	TUBE4-29-5L	3.5 Guide Tube ID=3.5mm OD=4.0mm Height=5mm Lip=1mm of total height	TUBE4-35-5L
2.9 Guide Tube ID=2.9mm OD=5.0mm Height=5mm Lip=1mm of total height	TUBE5-29-5L	3.5 Guide Tube ID=3.5mm OD=5.0mm Height=5mm Lip=1mm of total height	TUBE5-35-5L
2.9 Guide Tube ID=2.9mm OD=5.0mm Height=5mm Lip=1mm of total height	TUBE5-29-5L	3.6 Guide Tube ID=3.6mm OD=4.0mm Height=5mm Lip=1mm of total height	TUBE4-36-5L
2.92 Guide Tube (5 Pack) ID=2.92mm OD=3.92mm Height=5mm Lip=1mm of total height	TUBE292	3.68 Guide Tube (5 Pack) 3.5mm Short/Long, Bio Trilobe ID=3.68mm OD=4.68mm Height=5mm Lip=1mm of total height	TUBE368
3.0 Guide Tube ID=3.0mm OD=5.0mm Height=5mm Lip=1mm of total height	TUBE5-3-5L	3.75 Guide Tube ID=3.75mm OD=4.4mm Height=5mm Lip=1mm of total height	TUBE44-375
3.15 Guide Tube ID=3.15mm OD=4.4mm Height=5mm Lip=1mm of total height	TUBE44-315	3.79 Guide Tube ID=3.79mm OD=4.4mm Height=5mm Lip=1mm of total height	TUBE44-379
3.3 Guide Tube ID=3.3mm OD=4.0mm Height=5mm Lip=1mm of total height	TUBE4-33-5L	3.9 Guide Tube ID=3.9mm OD=5.0mm Height=5mm Lip=1mm of total height	TUBE5-39-5L
4.1 Guide Tube ID=4.1mm OD=5.0mm Height=4mm Lip=1mm of total height	TUBE5-41-4L	4.45 Guide Tube (5 Pack) 4.3mm Short / Long, Bio Trilobe ID=4.45mm OD=5.45mm	TUBE445

All prices are available in the product section of our website. Volume discounts are available for some items.  
Blue Sky Bio is not affiliated with Zimmer Dental®.

## Guide Tubes

Size	Part #	Size	Part #
4.1 Guide Tube (5 Pack) ID=4.1mm OD=5.1mm Height=3.5mm Lip=1mm of total height	TUBE51-41-35L	4.52 Guide Tube ID=4.52mm OD=5.57mm Height=4mm Lip=1mm of total height	TUBE557-452-4L
4.15 Guide Tube (5 Pack) ID=4.15mm OD=5.15mm Height=5mm Lip=1mm of total height	TUBE415	4.68 Guide Tube ID=4.68mm OD=5.3mm Height=5mm Lip=1mm of total height	TUBE53-468
4.2 Guide Tube ID=4.2mm OD=5.0mm Height=4.5mm Lip=1mm of total height	TUBE5-42-45L	4.7 Guide Tube (5 Pack) ID=4.7mm OD=5.7mm Height=4mm Lip=1mm of total height	TUBE57-47-4L
4.25 Guide Tube (5 Pack) ID=4.25mm OD=5.25mm Height=4mm Lip=1mm of total height	TUBE525-425-4L	5.0 Guide Tube (5 Pack) ID=5.0mm OD=6.0mm Height=3.5mm Lip=1mm of total height	TUBE6-5-35L
4.25 Guide Tube (5 Pack) ID=4.25mm OD=5.25mm Height=5mm Lip=1mm of total height	TUBE425	5.0 Guide Tube ID=5.0mm OD=6.2mm Height=4mm Lip=1mm of total height	TUBE62-5-4L
4.25 Guide Tube ID=4.25mm OD=5.3mm Height=5mm Lip=1mm of total height	TUBE53-425	5.02 Guide Tube (5 Pack) ID=5.02mm OD=6.02mm Height=5mm Lip=1mm of total height	TUBE502
4.35 Guide Tube ID=4.35mm OD=5.27mm Height=6mm Lip=1mm of total height	TUBE527-435-6L	5.06 Guide Tube (5 Pack) ID=5.06mm OD=6.02mm Height=3.5mm Lip=1mm of total height	TUBE6-506-35L
5.08 Guide Tube (5 Pack) ID=5.08mm OD=6.08mm Height=5mm Lip=1mm of total height	TUBE508	5.5 Guide Tube ID=5.5mm OD=6.5mm Height=4mm Lip=1mm of total height	TUBE65-55-4L
5.1 Guide Tube ID=5.1mm OD=6.1mm Height=6mm Lip=1mm of total height	TUBE61-51-6L	5.7 Guide Tube (5 Pack) ID=5.7mm OD=6.7mm Height=4mm Lip=1mm of total height	TUBE67-57-4L
5.15 Guide Tube (5 Pack) ID=5.15mm OD=6.15mm Height=4mm Lip=1mm of total height	TUBE615-515-4L	6.13 Guide Tube ID=6.13mm OD=6.95mm Height=3.2mm Lip=1mm of total height	TUBE695-613-32L

All prices are available in the product section of our website. Volume discounts are available for some items.  
Blue Sky Bio is not affiliated with Zimmer Dental®.

## Guide Tubes

Size	Part #	Size	Part #
5.15 Guide Tube (5 Pack) ID=5.15mm OD=6.15mm Height=4mm Lip=1mm of total height	TUBE615-515-4L	6.13 Guide Tube ID=6.13mm OD=6.95mm Height=3.2mm Lip=1mm of total height	TUBE695-613-32L
5.16 Guide Tube (5 Pack) 5.0mm Short, Bio Trilobe ID=5.16mm OD=6.16mm Height=5mm Lip=1mm of total height	TUBE516	6.2 Guide Tube ID=6.2mm OD=6.9mm Height=4mm Lip=1mm of total height	TUBE69-62-4L
5.25 Guide Tube (5 Pack) ID=5.25mm OD=6.25mm Height=4mm Lip=1mm of total height	TUBE625-525-4L	6.2 Guide Tube (5 Pack) ID=6.2mm OD=7.2mm Height=3.5mm Lip=1mm of total height	TUBE72-62-35L
5.25 Guide Tube (5 Pack) ID=5.25mm OD=6.25mm Height=5mm Lip=1mm of total height	TUBE525	6.26 Guide Tube (5 Pack) ID=6.26mm OD=7.21mm Height=3.5mm Lip=1mm of total height	TUBE72-626-35L
5.31 Guide Tube ID=5.31mm OD=6.2mm Height=4.5mm Lip=1mm of total height	TUBE62-531-45L	6.3 Guide Tube ID=6.3mm OD=7.3mm Height=6mm Lip=1mm of total height	TUBE73-63-6L
5.35 Guide Tube (5 Pack) ID=5.35mm OD=6.35mm Height=4mm Lip=1mm of total height	TUBE635-535-4L	6.72 Guide Tube ID=6.72mm OD=7.17mm Height=5mm Lip=1mm of total height	TUBE717-672

All prices are available in the product section of our website. Volume discounts are available for some items.  
Blue Sky Bio is not affiliated with Zimmer Dental®.



# Terms & Conditions – Important User Information

## Blue Sky Bio, LLC - TERMS AND CONDITIONS – Important User Information

Blue Sky Bio offers high quality dental implant products at much lower prices, compared to its competitors. To help keep our overhead low and prices value-minded, we only accept returns or exchanges under *very limited circumstances*.

### NO RETURNS

Blue Sky Bio does not accept returns. Contact us before attempting to return products. When your products arrive, inspect the packaging and the contents for damage and defects. You must notify us within 7 days from date of original sales receipt if, product packaging is damaged, illegible, or has a broken safety seal; or if product itself appears to be damaged or does not function as its intended use. In these cases, Blue Sky Bio will pay return shipping charges, and will pay shipping charges of replacement products. Blue Sky Bio does not offer a credit or reimburse for implants that do not integrate. All returned products are subject to inspection prior to any credit/refund authorization. Products returned, that do not meet the exceptions listed above, will incur a restocking fee and may be subject to no credit/refund authorization.

A Return Authorization Number (RA#) must be obtained before returning products.

### ORDER PLACEMENT

Blue Sky Bio accepts payment for purchases with Visa, MasterCard, and American Express, through its secure website or in limited circumstances, with our fax order form. Prices for products, sales tax, shipping, or any other charges will be listed on your sales receipt. Full payment is due before orders are shipped. Sales are final after shipment has left our distribution center. Blue Sky Bio reserves the right to hold orders until credit card information can be confirmed. You may be contacted by a Blue Sky Bio representative regarding your purchase.

### SHIPPING

Orders placed within the United States are shipped via UPS. Orders placed outside the United States are shipped via Fedex. Customers are ultimately responsible to ensure that carriers will deliver at the requested time in their areas. Orders placed before 11am CST will ship the same day. Orders placed after 11am CST may not ship until the next business day. Blue Sky Bio recognizes holidays throughout the year. Watch our home page for notices regarding company closings due to holidays, as this will affect shipping delivery dates.

### INTERNATIONAL BROKER / TAX TERMS

Blue Sky Bio utilizes Fedex Express (FE) to ship and broker all orders from the United States to your door. As broker, FE pays all taxes, tariffs, and VAT due on shipments. FE will bill you separately for these charges after you receive your order, including their broker fee. Taxes and broker fees are not part of your shipping charge collected at time of order. By placing your order you authorize Blue Sky Bio to collect any taxes not paid, as soon as reported by FE of tax delinquency, via your credit card on file. You will be responsible for any additional charges or late fees associated with not paying responsible taxes, tariffs, and VAT promptly.

### CONTACTING BLUE SKY BIO

Contacting us is very easy and convenient. Call us toll-free 9am – 5pm CST at, **888-446-6724**, or email us anytime at, [info@blueskybio.com](mailto:info@blueskybio.com).

### Important Product Notices For Blue Sky Bio Customers

Blue Sky Bio internal hex dental implants are compatible with Zimmer Dental's Tapered Screw Vent® prosthetics, and instrumentation. Blue Sky Bio implants have a patent-pending thread design and should not be inserted with mounts from other companies.

With the exceptions listed above no other companies products should be used with our system.

Federal Law restricts these devices to sale by or on order of a licensed dentist or physician.

Blue Sky Bio is not affiliated with Zimmer Dental.

Tapered Screw Vent® is a registered trademark of Zimmer Dental.